

**ON-BOARD**

**SPLIT  
VERSION**

**COMPACT  
VERSION**

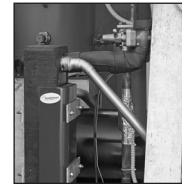

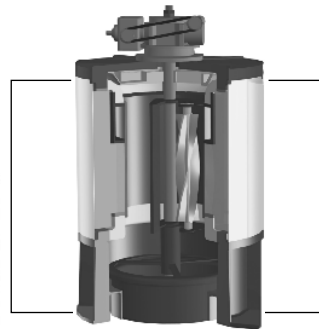



**Scale Ice  
Makers Units**

**Unité de  
Production  
de Glace  
en Ecailles**

**Scherbeneis  
Produktions-  
einheit**

**Fabricador  
de Hielo  
en Escamas**

**Unità di  
Produzione  
Ghiaccio  
in scaglie**

Fresh Water	Sea Water <i>NaCl</i>	24h 		24h 		 [v/Hz/ph]	 [WxDxH mm]    [xHWxD inches]	 R404a or R22
		Ambient T. +25°C (77°F) Water T. +15°C (59°F) [kg]    [lbs]	Ambient T. +32°C (90°F) Water T. +21°C (70°F) [kg]    [lbs]	Ambient T. +25°C (77°F) Water T. +15°C (59°F) [kg]    [lbs]	Ambient T. +32°C (90°F) Water T. +21°C (70°F) [kg]    [lbs]			
EVE 200 WS	EVE 200 WS SW	1.900	4.188	1.600	3.530	400/50Hz/3ph 230/60Hz/3ph	2150x1900x1360    84 5/8" x 74 3/4" x 53 1/2"	R404a or R22
EVE 300 WS	EVE 300 WS SW	2.900	6.392	2.300	5.070	400/50Hz/3ph 230/60Hz/3ph	2150x1900x1360    84 5/8" x 74 3/4" x 53 1/2"	R404a or R22
EVE 400 WS	EVE 400 WS SW	3.900	8.596	3.500	7.720	400/50Hz/3ph 230/60Hz/3ph	2150x1900x1750    84 5/8" x 74 3/4" x 68 7/8"	R404a or R22
EVE 650 WS	EVE 650 WS SW	6.200	13.665	5.800	12.790	400/50Hz/3ph 230/60Hz/3ph	2850x2250x1750    112 1/4" x 88 5/8" x 68 7/8"	R404a or R22
EVE 800 WS	EVE 800 WS SW	7.650	16.861	7.500	16.530	400/50Hz/3ph 230/60Hz/3ph	3450x1990x2020    135 7/8" x 78 3/8" x 79 1/2"	R404a or R22
EVE 1000 WS	EVE 1000 WS SW	9.800	21.599	9.000	19.840	400/50Hz/3ph 230/60Hz/3ph	4350x2310x2100    171 1/4" x 91" x 82 5/8"	R404a/R22/R717
EVE 1300 WS	EVE 1300 WS SW	12.500	27.550	11.000	24.250	400/50Hz/3ph 230/60Hz/3ph	4850x2310x2400    191" x 91" x 94 1/2"	R404a/R22/R717
EVE 1500 WS	EVE 1500 WS SW	15.000	33.060	13.500	29.760	400/50Hz/3ph 230/60Hz/3ph	4850x2310x2400    191" x 91" x 94 1/2"	R404a/R22/R717

**1**

**Years Warranty  
Ans de Garantie  
Jahre Garantie  
Años de Garantía  
Anni di Garanzia**

Subject to certain limitations and exclusions  
Assujettie aux limites et exclusions prescrites  
Abhängig von Bestimmten Einschränkungen und Ausnahmen  
Sujeta a algunas limitaciones y exclusiones  
Soggetta ad alcune limitazioni ed esclusioni



This product qualifies for the following listings:



EVE200/300/400/650

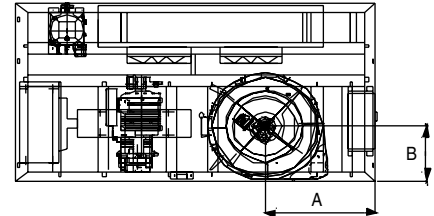
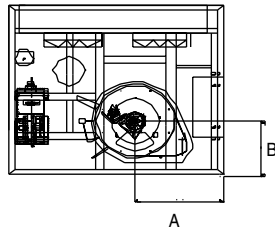
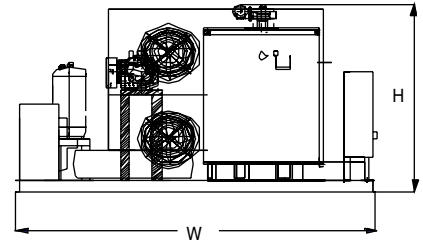
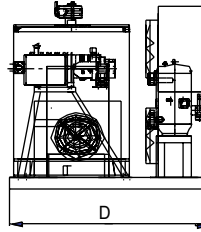
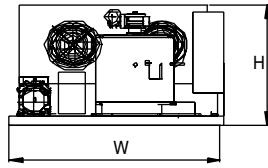
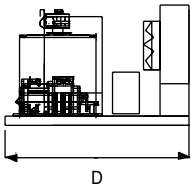

Fresh Water	Sea Water	Nominal Electrical Power KW	W mm	D mm	H mm	A mm	B mm	Ice Outlet (ø mm)	Inlet Water	Overflow (mm)	[kg]	[lbs]	[kg]	[lbs]
EVE 200 WS	EVE 200 WS SW	12,00	1900	1650	1160	750	435	420	1/2"	10	780	1719	t.b.a.	
EVE 300 WS	EVE 300 WS SW	16,00	1900	1650	1160	750	435	420	1/2"	10	800	1763	t.b.a.	
EVE 400 WS	EVE 400 WS SW	20,00	1900	1650	1550	750	435	420	1/2"	10	1.150	2535	t.b.a.	
EVE 650 WS	EVE 650 WS SW	35,00	2600	2000	1550	1035	545	670	1/2"	10	2.000	4408	t.b.a.	
EVE 800 WS	EVE 800 WS SW	35,00 (*)	3200	1740	1820	990	535	670	1/2"	10	2.220	4849	t.b.a.	
EVE 1000 WS	EVE 1000 WS SW	40,00 (*)	4100	2060	1900	1265	545	840	3/4"	10	2.950	6502	t.b.a.	
EVE 1300 WS	EVE 1300 WS SW	55,00 (*)	4600	2060	2200	1135	545	840	3/4"	10	3.750	8265	t.b.a.	
EVE 1500 WS	EVE 1500 WS SW	70,00 (*)	4600	2060	2200	1135	545	840	3/4"	10	4.300	9477	t.b.a.	

\*Screw compressor

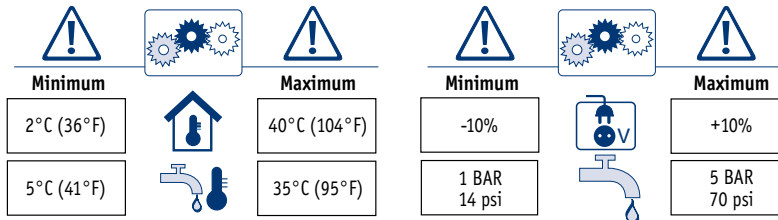

Features: heavy basement frame in HIB iron, galvanized; AISI 304 Stainless steel evaporator complete of expansion valve /refrigerant level control (R404a/R22); base and cover in Peralluman; dosing water pump; dripping-pan; gear-motor with system for ice-scraper rotation; semi-hermetic /screw compressor; Liquid receiver and oil separator; Filters for suction and liquid lines; oil filters for version 1000/1500; Copper piping with valves on main components in order to ease maintenance; Water cooled condenser (SW sea water); Automatic electrical control panel complete of main switch, power and auxiliary contactors, voltmeter and ammeter, pressure switch (refrigerant high/low/ oil), fan protections, ice-scraper protection, pump-down control. All versions are certified CE/PED.

Caractéristiques techniques: Structure portante HIB en acier galvanisé ; évaporateur en acier inox AISI 304 complet de détendeur /contrôle de niveau (R404a/R22); basement et couvercle en Peralluman; pompe dosage eau/sel; bassin écoulement eau; moteur qui entraîne fraise hélicoïdale acier inox; compresseur semi-hermétique/vis; récepteur de liquide et séparateur d'huile; filtres sur tuyaux aspiration et liquide; filtre huile pour modèles 1000/1500; tuyauterie en cuivre avec vanne sur les principaux composants pour simplifier l'entretien; condensateur eau (SW eau de mer); tableau électrique complet de interrupteur général, contacteurs puissance et auxiliaires, voltmètre et ampèremètre, pressostats (réfrigérant haute, basse et huile), protections ventilateurs et fraise, pump-down control. Tous les modèles sont certifiés CE/PED.

Technische Beschreibung: Trägerhäuse HIP aus verzinktem Stahl. Verdampfer aus AISI 304 Edelstahl komplett mit Expansionsventil und Kältemittelfüllstandsanzeige (R404a/R22). Rahmen und Abdeckung aus Peralluman. Dosierpumpe für Salz/Wasser. Auffangschale. Getriebe-motor mit Eisbrechereinheit. Halbhermetischer Verdichter oder Schraubenverdichter. Kältemittelsammler und Ölabscheider. Trockner in Saug- und Flüssigkeitsleitung. Ölfilter für die 1000/1500 Modelle. Absperrventile in den Kupferrohrleitungen für die leichte Wartung. Süßwasser Verflüssiger (WS) oder für Salzwasser (SW). Elektromechanische Anzeige mit Hauptschalter, Leistungs- und Hilfsschutz mit Spannungs- und Amperenzeige, Druckschalter für (Hoch/Nieder/ Öl). Schutzvorrichtung für Lüfter und Eisbrecher, Pump-down Schaltung. Alle Modelle sind zertifiziert mit CE/PED.

Características técnicas: Estructura portante HIB de acero galvanizado; evaporador de acero AISI 304 compuesto de válvula termostática/control de nivel (R404a/R22); base y tapa de Peralluman; bomba alimentación agua/sal; bandeja desagüe; motor rotación rompe-hielo de acero inox; compresor semihermético/tornillo; reserva de líquido y separador aceite; filtros en tubería aspiración y líquido; filtro aceite para modelos 1000/1500; tubería en cobre con válvulas de parcialización en todos los componentes principales para simplificar el mantenimiento; condensador agua (SW agua de mar); cuadro eléctrico compuesto de interruptor general, contactores potencia y auxiliares, voltmetro y ampermetro, presostatos (refrigerante alta, baja y aceite), protecciones ventiladores y rompe-hielo, control pump-down. Todos los modelos están certificados CE/PED.

Caratteristiche tecniche: Struttura portante HIP in acciaio zincato; evaporatore in acciaio inox AISI 304 completo di valvola termostatica/regolatore di livello (R404a/R22); base e coperchio in Peralluman; pompa dosatrice acqua/sale; ghiotta raccogli condensa; motoriduttore per rotazione rompihaccio in acciaio inox; compressore semi-hermetico/vite; ricevitore di liquido e separatore d'olio; filtri su mandata e aspirazione; filtro olio per modelli 1000/1500; tubazioni in rame con rubinetti di parzializzazione sui principali componenti per facilitare la manutenzione; condensatore ad acqua (SW acqua di mare); quadro elettrico completo di interruttore generale, contattore di potenza e ausiliari, voltmetro e amperometro, pressostati (refrigerante alta, bassa e olio), protezioni ventilatori e rompihaccio, controllo pump-down. Tutte le macchine sono certificate CE/PED.

**Scotsman**® The one the world relies on.  
Ice Systems

Certified ISO 9001:2000

<p><b>USA, Canada, Latin America</b> Scotsman Ice Systems USA 775 Corporate Woods Parkway Vernon Hills, IL 60061 Ph: (+1) 847 215-4550 Fax (+1) 847 913-9844 customer.service@scotsman-ice.com</p>	<p><b>Europe</b> Scotsman Europe-Frimont S.p.A. Via Puccini, 22 20010 Pogliano (Milano) Italy Ph: (+39) 02-93960208 Fax: (+39) 02-93960201 scotsman.europe@frimont.it</p>	<p><b>Asia and Pacific</b> Scotsman Ice Systems-Frimont S.p.A. (R.O.) 627A Aljunied Road #04-04 Biztech Centre Singapore 389842 Ph: (+65) 6738 5393 Fax: (+65) 6738 1959 scotsice@singnet.com.sg</p>	<p><b>China</b> Scotsman Ice Systems (Shanghai) Co., Ltd Room 405-407 Jing'an China Tower 1701 West Beijing Road-200040 Shanghai Ph: (+86) 21-62476056-Fax: (+86) 21-62476126 scotsmansh@online.sh.cn</p>	<p><b>Middle East &amp; N. Africa</b> Scotsman Ice Systems Dubai Office P.o. Box 21648 Sharjah - U.A.E. Mobile: Ph: (+971) 505505980 Fax (+971) 6-5654063 scotsman@eim.ae</p>	<p><b>South Africa</b> Scotsman Ice Systems SA (PTY) Ltd. 10, Rhodes Street - Kensington B P.o. Box 44 - Riverclub 2149 Ph: (+27) 11-7898400 Fax (+27) 11-7898411 scotsman@telkomsa.net</p>
--	---	--	---	---	---